

Jerry's Apartment

129 West 81st Street, Apartment 5A

DIY Cut and Fold Kit

WHAT YOU WILL NEED:

- 7 Sheets of Double Sided Matte Photo Paper, 61lb thickness or heavier. Don't use glossy photo paper, because it has a backing on it that makes it hard to fold and get a crisp clean edge.
- Printer with color ink.
- Craft knife (or scissors)
- Straight edge
- Double sided tape
- Glue stick
- Scoring tool

INSTRUCTIONS:

- 1) PRINT all project pages on your matte photo paper on the finest setting. Allow pages to dry before handling.
- 2) Using the SCORING tool and the straight edge, score all the black dotted lines so they are easier to fold later.
- 3) Using the craft KNIFE and straight edge, cut along all the green dotted lines carefully. (Adults only) If you mess up, don't sweat it, just reprint and try again!
- 4) FOLD along all the black dotted lines.
- 5) To make the furniture, you will be making boxes. Fold all sides of the box and tuck in the tabs. Apply glue stick to the tabs to secure.
- 6) Attach the wall sections to each other first, then line up the wall sections to the floor and use glue stick or double sided tape to attach them together.

If you want to guest star on the show, take a full length picture of yourself in front of a white wall and print it so it is about 2¼ inches tall, then attach a base and you can join the cast.
Make a Vine and share on Twitter! @alanronay

SCAVENGER HUNT:

- ❑ Picture of Keith Hernandez, who guest starred in Season 3, Ep 17/18 "The Boyfriend," and is one of Jerry's favorite baseball players.
- ❑ Shirt Kramer convinces Jerry to wear in Season 5, Ep 2, "The Puffy Shirt"
- ❑ Boots Jerry wears when Kramer takes all his sneakers in Season 6. Ep 8, "The Mom and Pop Store"
- ❑ Fur Coat Jerry wears and pretends is his in Season 9, Ep 12, "The Reverse Peephole"
- ❑ NY Yankees hat, one of Jerry's favorite baseball teams
- ❑ Superman Action Figure, Jerry's favorite superhero
- ❑ Umbrella from Jerry's days as an umbrella salesman, where he invented the twirl to make umbrellas more attractive, or so he says.
- ❑ Toothbrush Jerry's girlfriend uses after it falls into the toilet and then Jerry kisses her in Season 8, Ep 16, "The Pothole".

Tips and Techniques

Folding

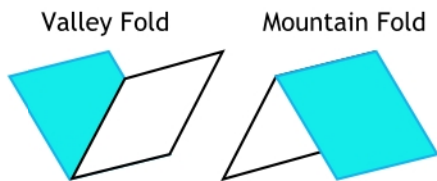

Making Boxes

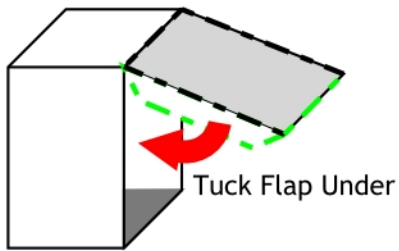

Cut vs Fold

CUT - - - - -
FOLD - - - - -

Pro Tips

Resist the urge to use a glue gun or liquid glue. Liquid glue will dampen the paper and make it warp, and a glue gun is overkill.

For a sturdier model, mount the wall pages and floor pages onto 1/4 inch foam board or matte board using spray adhesive or glue stick.

Glue

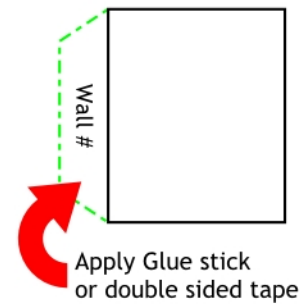

Couch/Chair

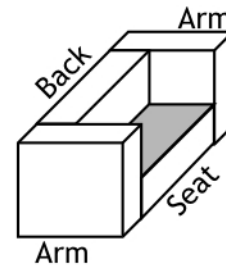

Assembly Guide

Jerry's Apartment

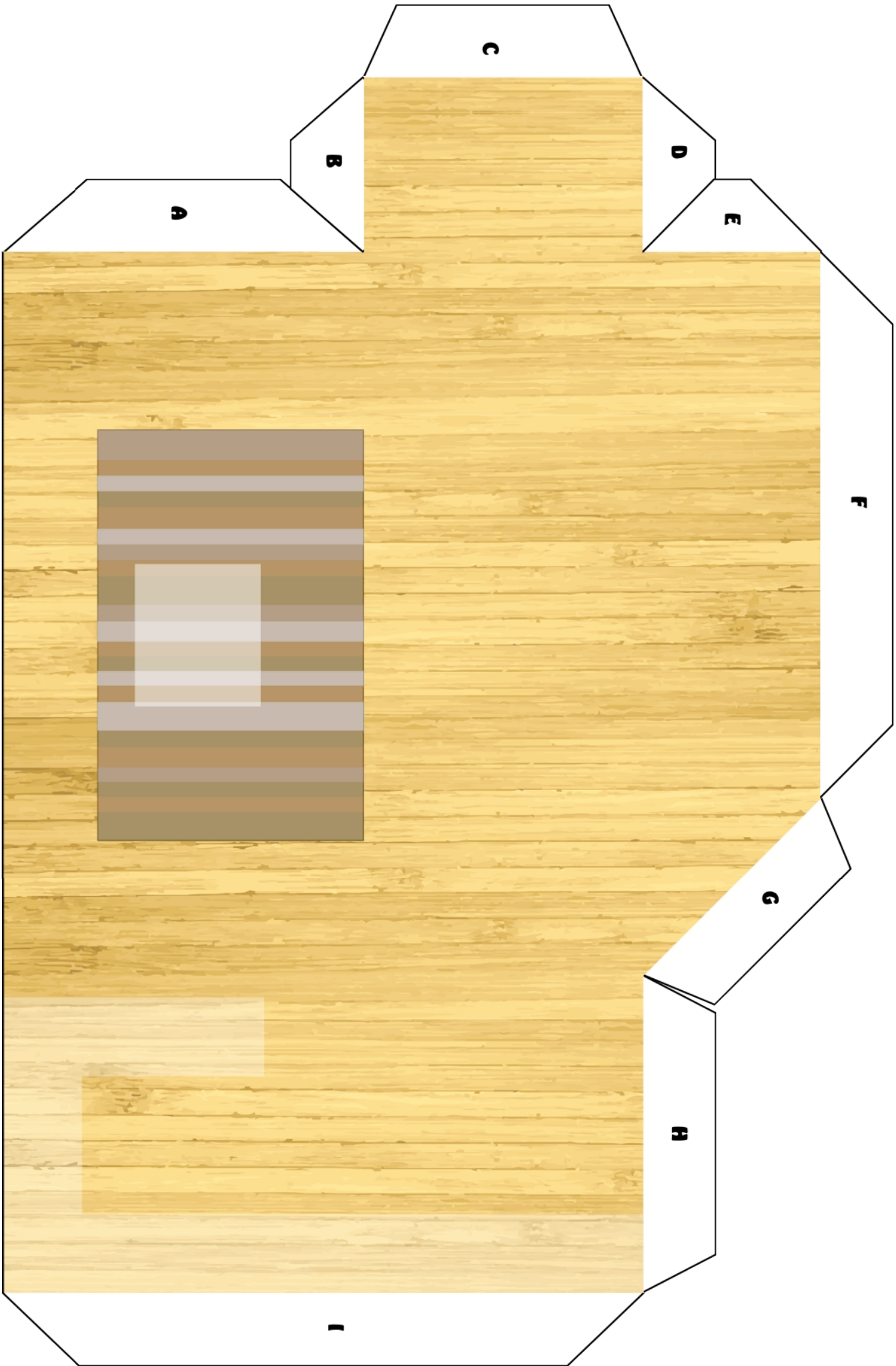

Jerry's Apartment



Jerry's Apartment

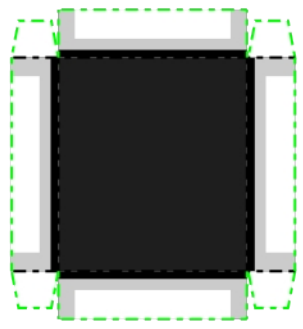
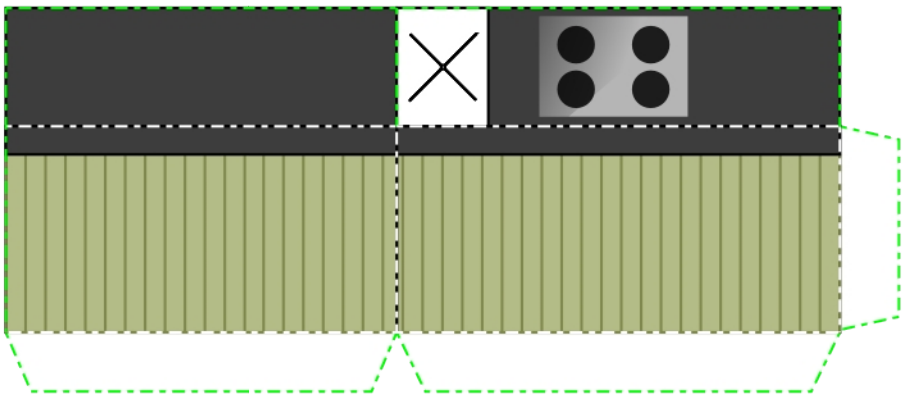
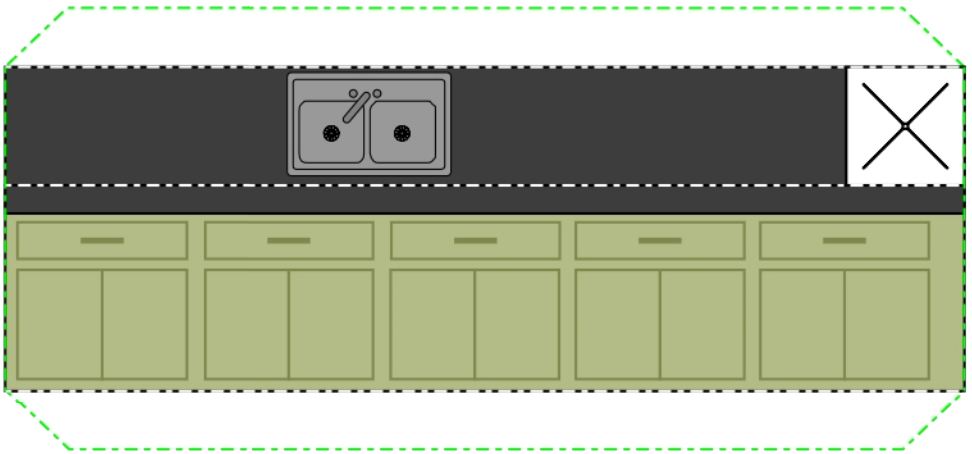
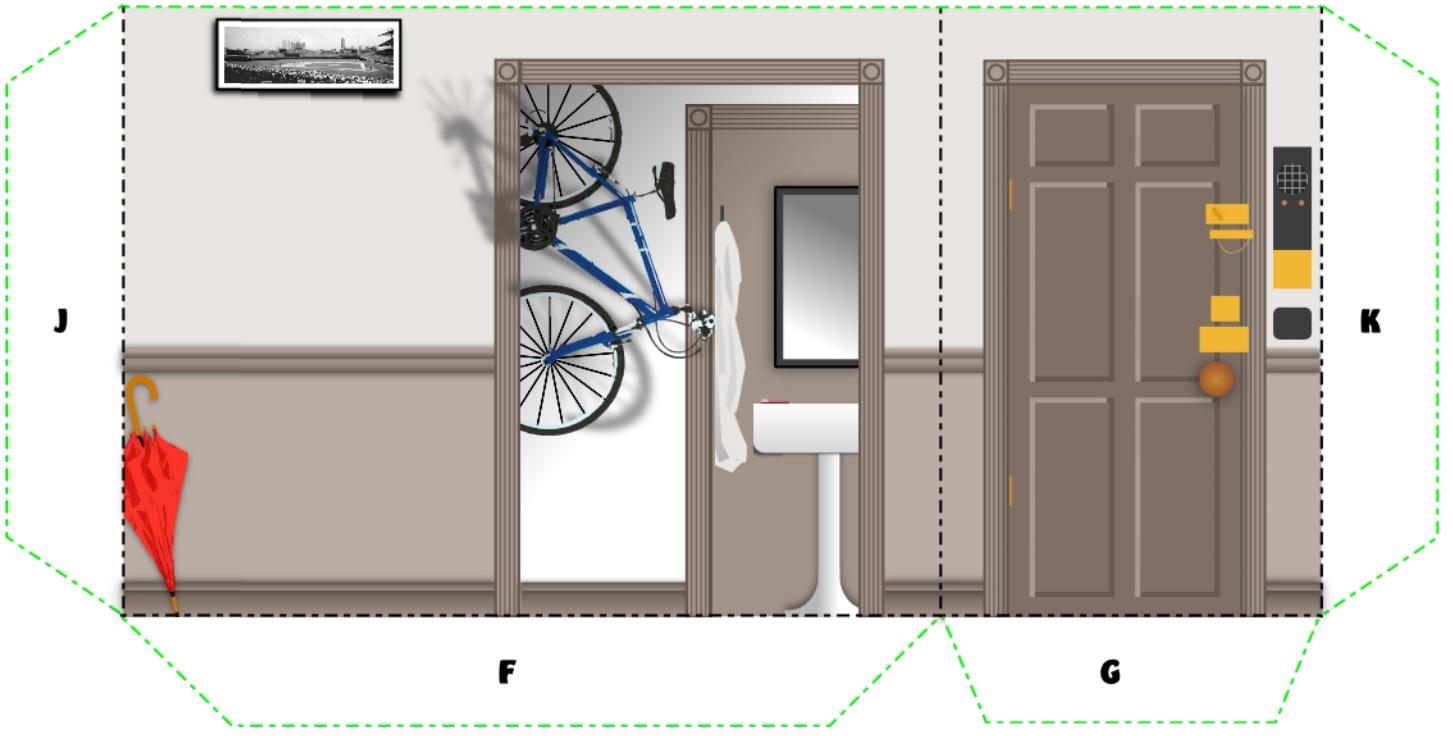

Jerry's Apartment

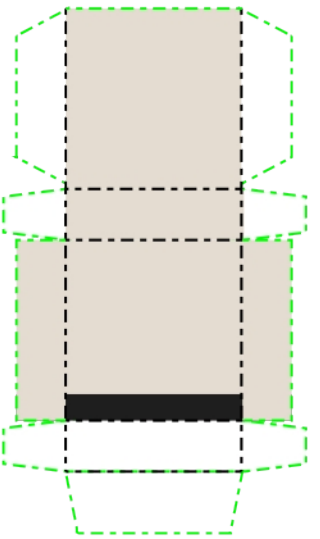
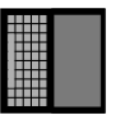

Back

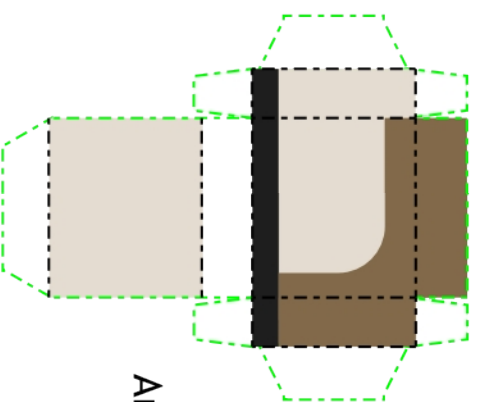

Arms

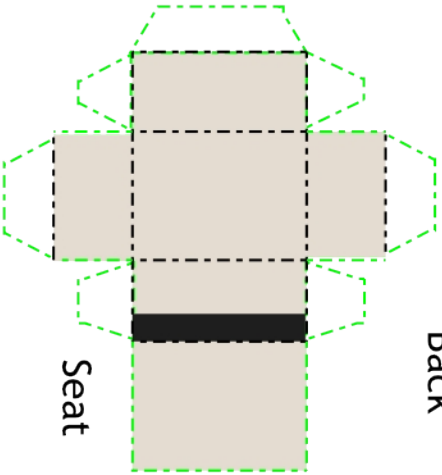
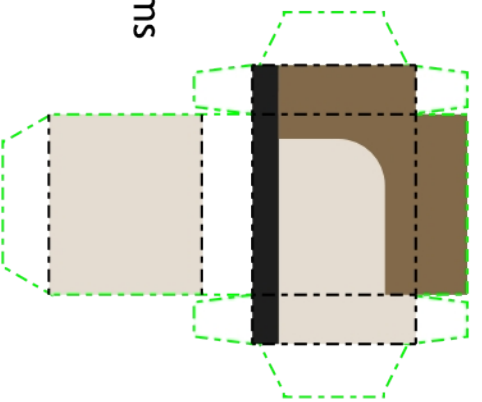

Seat

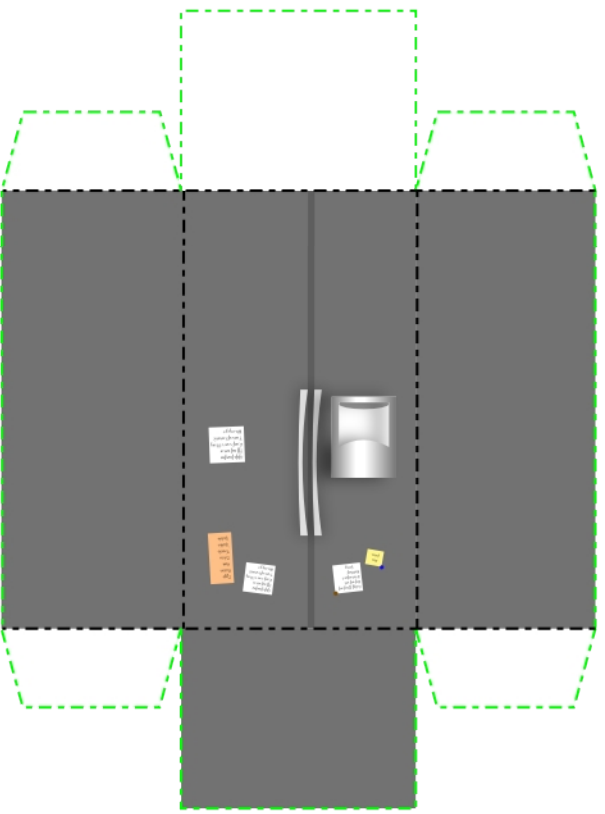
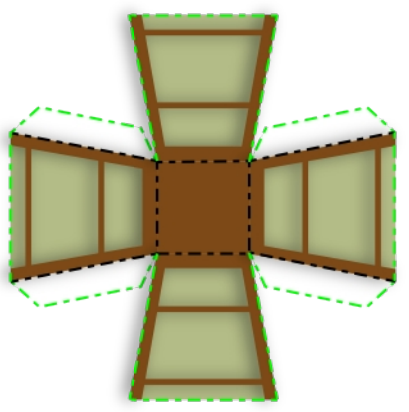
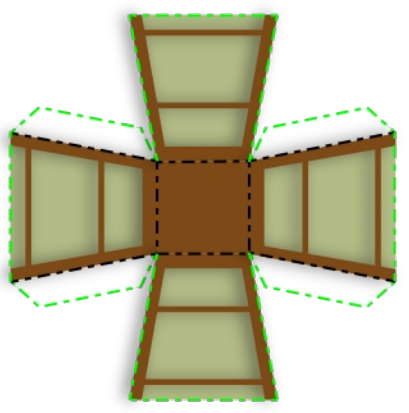

Jerry's Apartment

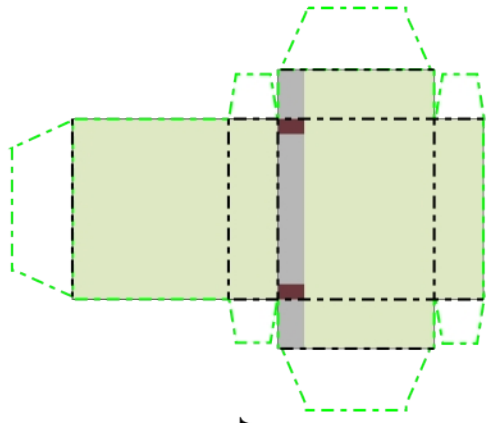

Arms

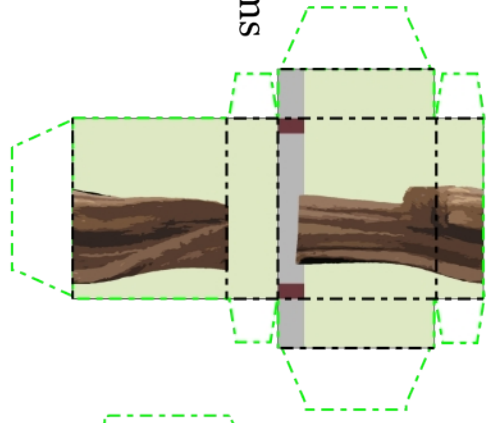

Back

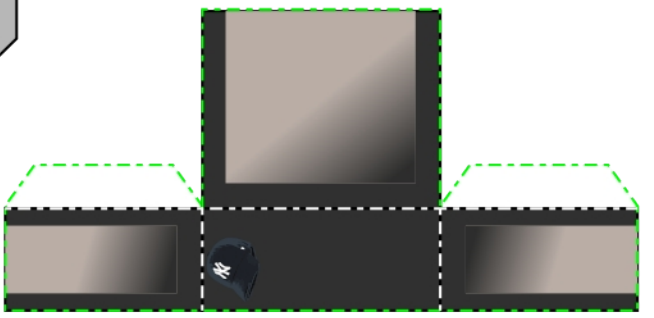

Dinner Table
Cut the grooves and thread the table edge through. Glue the two ends of the table edge together as they meet. Cover up Tabs with Chairs.



Fold here



Groove

Fold Over

Table Edge



Seat

